

THIS DOCUMENT IS THE PROPERTY OF
KEYSTONE ELECTRONICS CORP. AND
SHALL NOT BE REPRODUCED, DISTRIBUTED
OR USED AS A BASIS FOR MANUFACTURE
WITHOUT PRIOR WRITTEN PERMISSION
FROM KEYSTONE ELECTRONICS CORP.

MOUNTING DETAIL

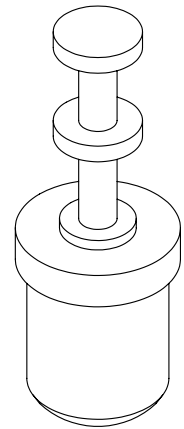
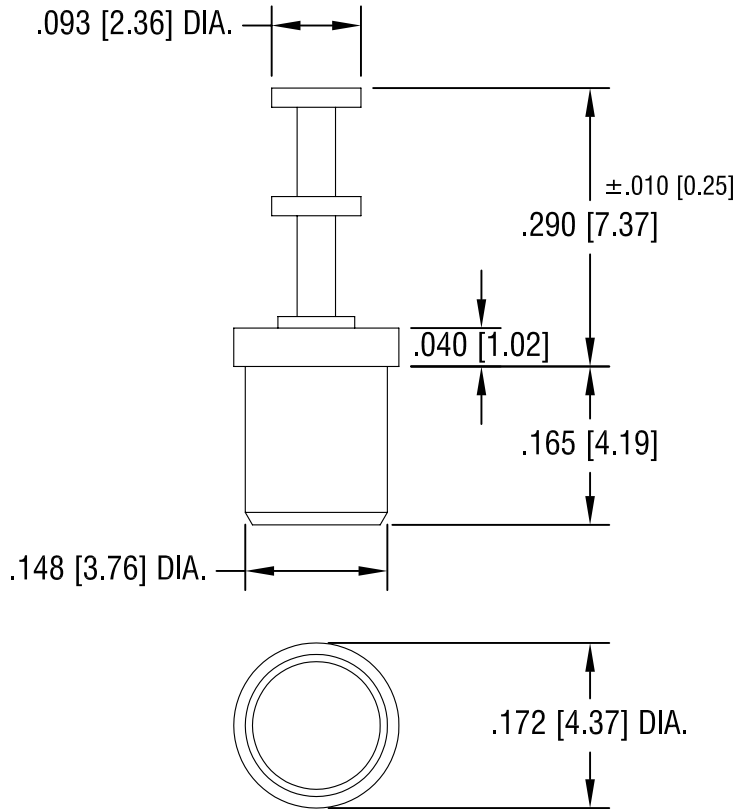

NOTES:

- 1. PIN: MAT'L - BRASS
FINISH: TIN
- 2. BUSHING: MAT'L - PTFE (TEFLON)
COLOR: WHITE

KEYSTONE ELECTRONICS CORP.			
ASTORIA, N.Y. 11105-2017			
PART NAME		PTFE INSULATED TERMINAL	
MATERIAL		AS NOTED	
FINISH		DRN BY	DATE
AS NOTED		N.T.	11.06.07
		APP'D	SCALE
		LN	5X
TOLERANCES	INCH [MM]	CODE	DWG NO.
DECIMAL	± .005 [± 0.15]	C	11306
ANGULAR	± 1°		
UNLESS OTHERWISE SPECIFIED			

DATE	DESCRIPTION	REV.