

THESE DRAWINGS ARE THE PROPERTY OF QUALTEK ELECTRONICS AND NOT TO BE REPRODUCED FOR OR COMMUNICATED TO A THIRD PARTY WITHOUT THE EXPRESS WRITTEN PERMISSION OF AN OFFICER OF QUALTEK ELECTRONICS.

REVISION			
REV.	DESCRIPTION	DATE	APPROVED

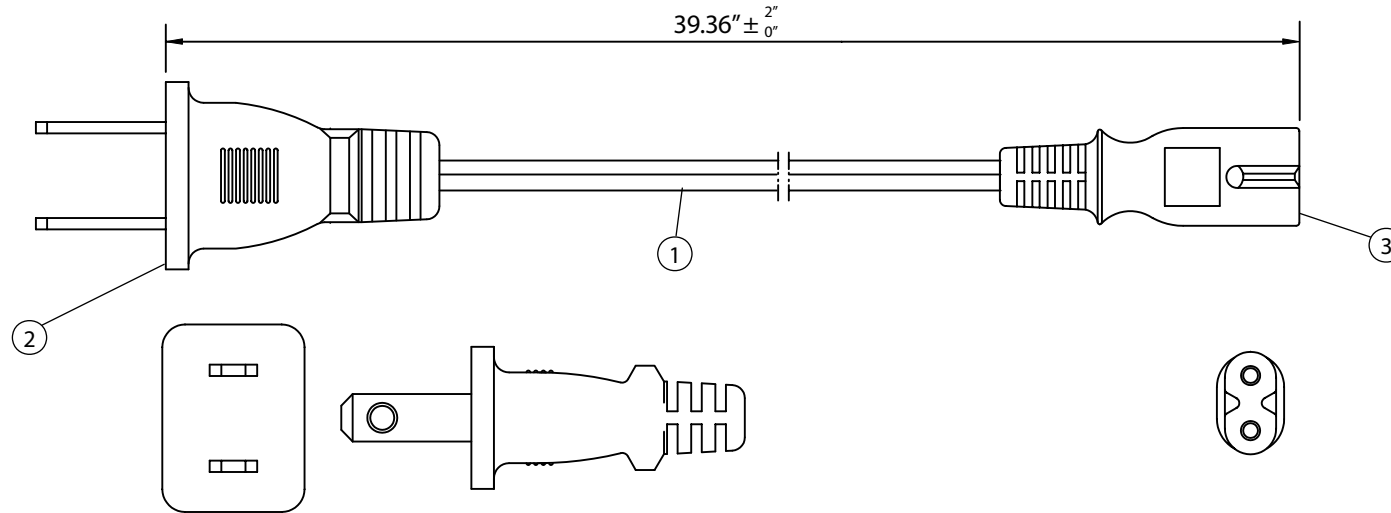

NOTES:

1. CORDAGE: SPT-2, 18AWG / 2C, UNSHIELDED, TEMP. RATING: 105°C, RATING: 125V 10A, JACKET COLOR: BLACK
2. PLUG: NEMA 1-15P
3. CONNECTOR: IEC 60320 C7
4. APPROVALS: UL, cUL
5. ROHS COMPLIANT

**CONTROLLED**

Dim range (mm)		Tolerance +/- (mm)		<b>Qualtek Electronics Corp.</b> PPC DIVISION		
0-1	0.15	Part Number: 223051-01		<div style="border: 1px solid green; padding: 2px; display: inline-block;">RoHS Compliant</div>		
1-6	0.20	Description: POWER CORD				
6-18	0.30					
18-50	0.50	UNIT: in				
50-120	0.70	Drawn / Date	Checked / Date	Approved / Date		
120-250	0.90	R.Nuti 07-20-17	07-20-17	LY / 07-20-17		
250-500	1.20					